

TAC Backfill Grout Injection

Two Component Backfill Grout Injection



Contents of Presentation

1. Introduction of TAC Corporation
2. Experience of Backfill Grout Injection
3. Two Components Backfill Grout Injection
4. Outline of TAC Simultaneous
Backfill Grouting Injection Pipe System
5. Outline of E-TAC Backfill Grouting System
6. Injection Method of E-TAC System
7. Maintenance for E-TAC System

1. Introduction of TAC Corporation

- 1932 : Establishment of Corporation
- 1976 : Development “Two Components type Backfill Grout Injection method” for TBM tunnel construction
- For 30 years until now, always continued development and the improvement of equipment and the material.

Our Corporate Activities

- Development, sales and lease of the backfill grout and the additive injection equipment for TBM tunnel construction.
- Development and sales of the backfill grout injection and the additive injection materials.
- Development and sales of the simultaneous backfill grout injection pipes for the shield type TBM.
- Sales of soil improvement materials for mud slime and wasted soil, generated from the construction site.
- Consulting service on design and planning of construction for tunnels and foundation works.



Automatic Plant for Backfill grout & Additive Injection

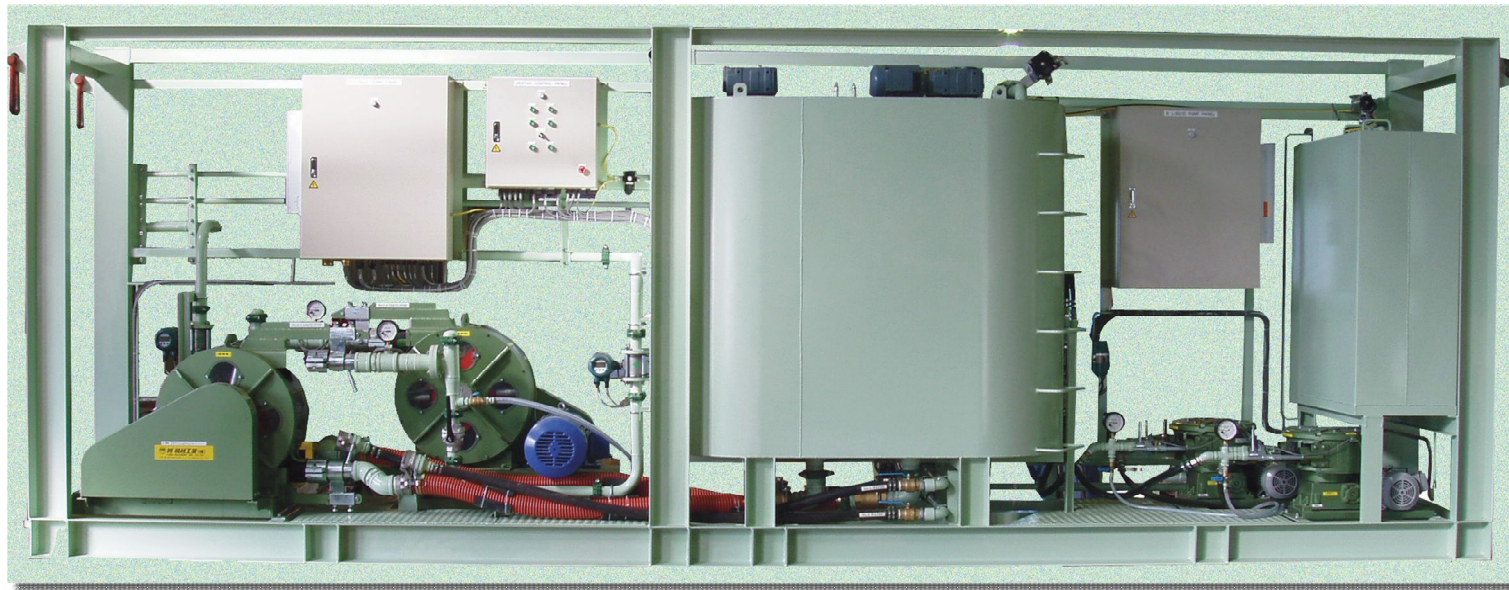

Automatic backfill grout & additive injection system



3rd Generation Type Simultaneous Backfill Grout Injection Pipe

Featuring to mix 2 liquids at
the rear end of the pipe

Minipacker

Segment fixation implement
for
Sharp curve tunnel construction

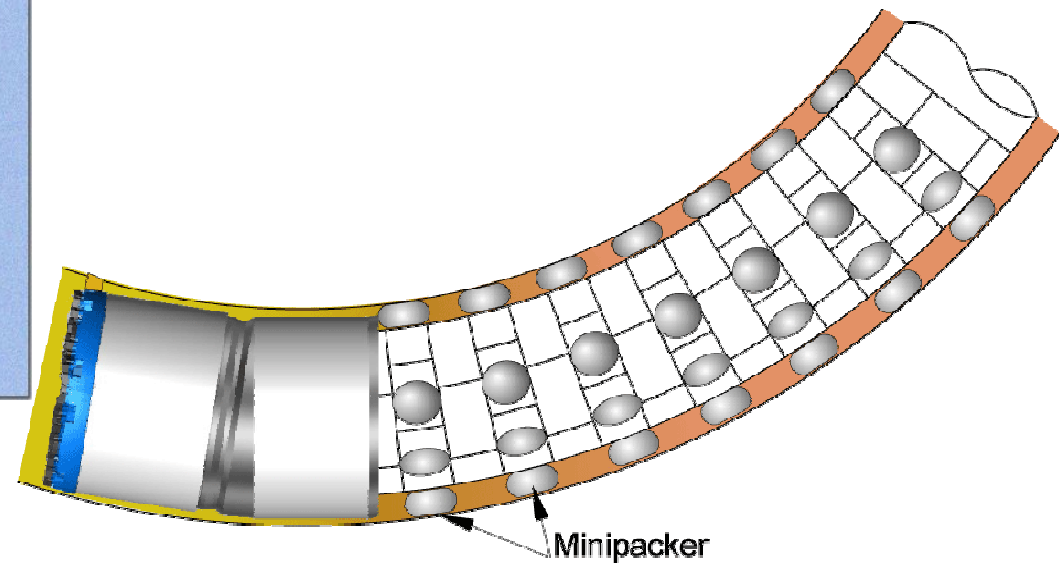

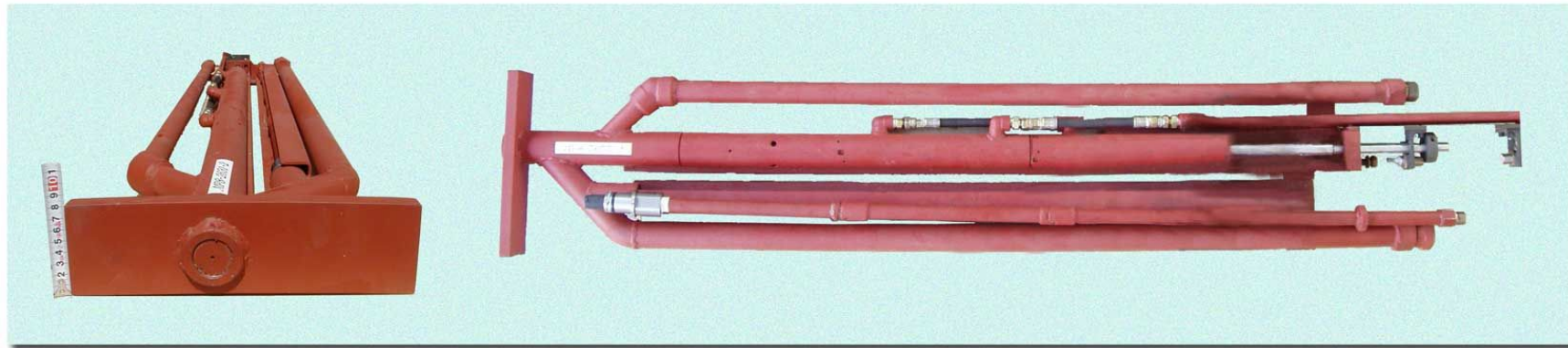

3.5th Generation Type Simultaneous Backfill grout Injection Pipe

Setting into the tail body of
the shield type TBM

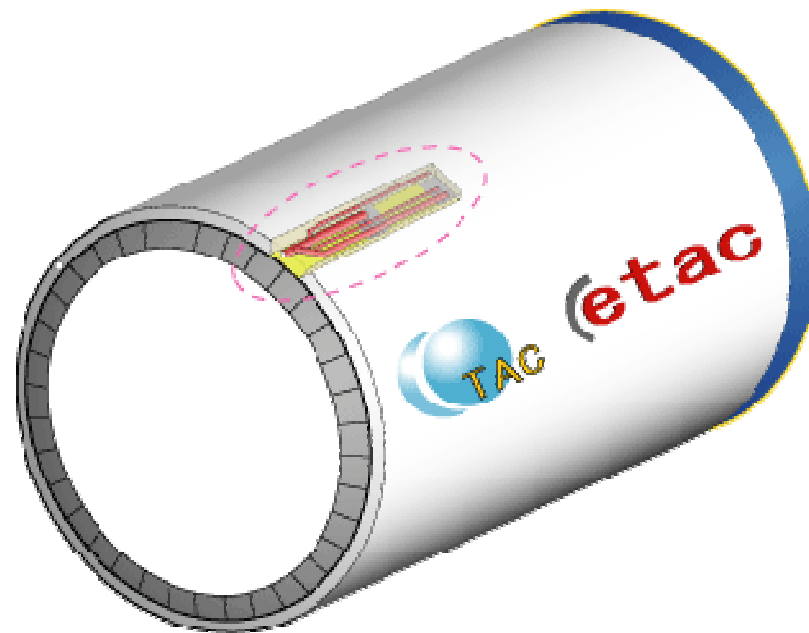

2. Experience of Backfill Grout Injection

- TAC has achieved 1000 projects in Japanese domestic TBM tunnel construction.
- Two components backfill grout injection was adopted to 99% of Japanese domestic projects in 2003.
- TAC has 25% share of the two components backfill grout injection in Japanese market.

- TAC has 45 nos. of oversea projects experience

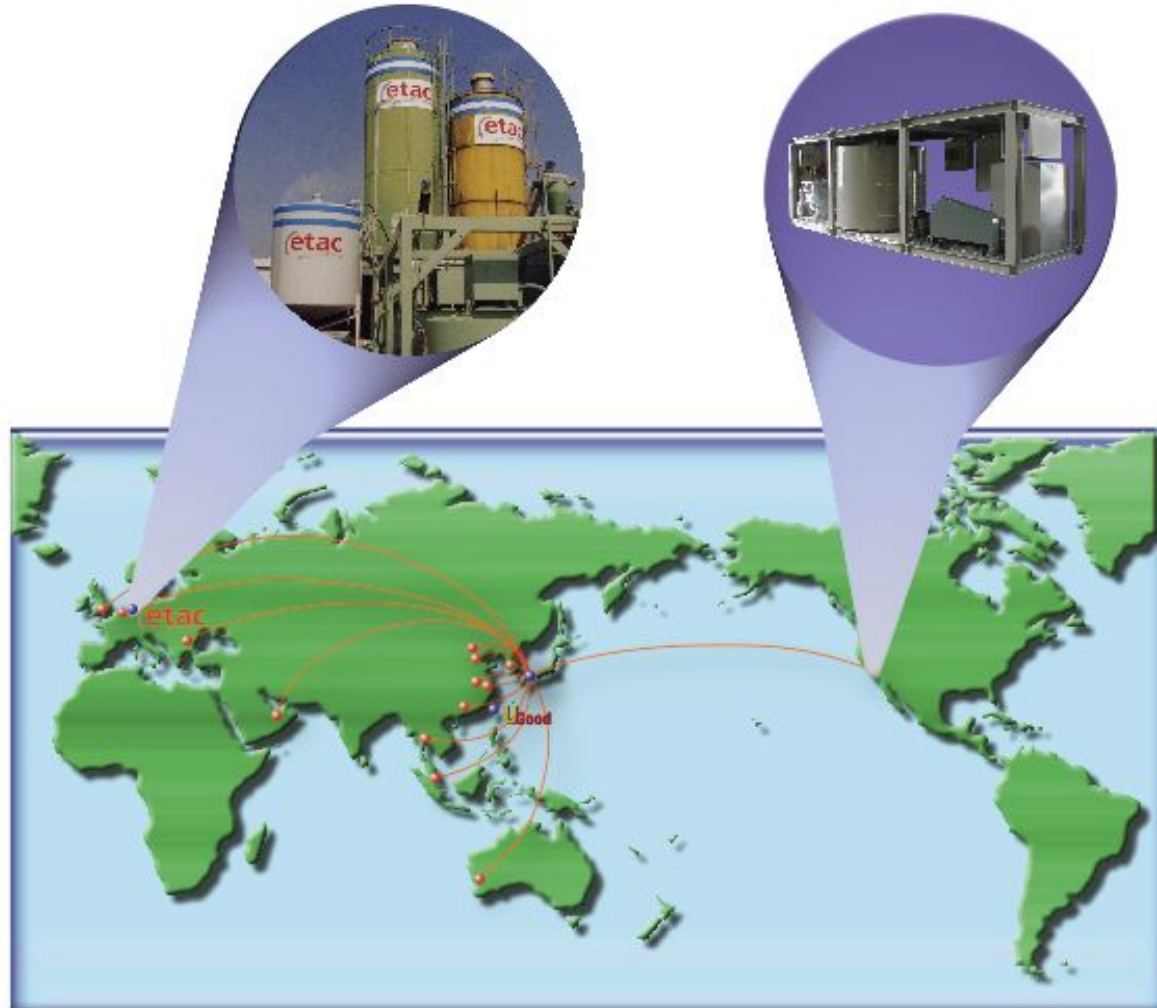

Especially in Europe

- 1998 : Conclusion of technical cooperation with NBC, Netherlands, concerning the backfill grout injection.
- Establishment of ETAC Corporation.
- 1999 : Adopted to Botlekspoor tunnel project in NL
- Adopted to CTRL C220 and C250 projects in UK
- Got very good results and successfully finished for all of these projects

3. Two Components Backfill Grout Injection

Backfill grouting is the construction method to fill up the gap between TBM excavation and segmental lining, which called “Tail Void”.

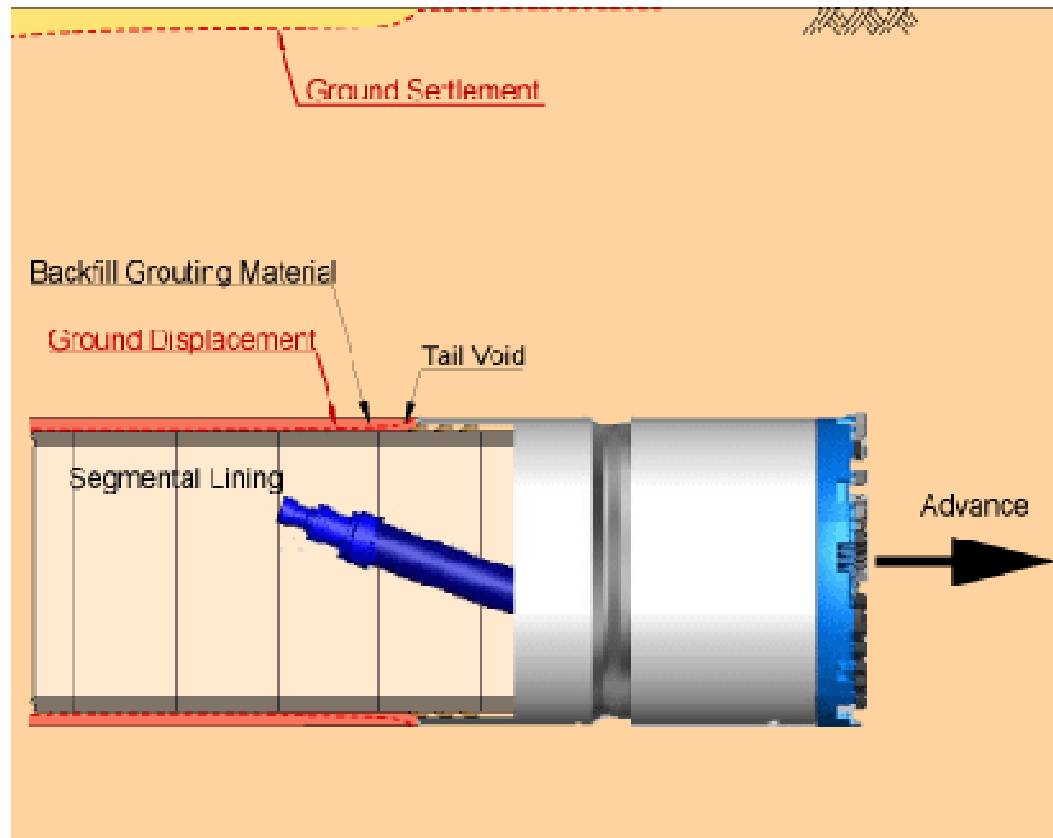

- Prevent the ground movement and surface settlement due to the volume loss at the tail void
- Stabilize the segmental lining in the ground
- Improve water tightness of the segmental lining

Diagram on the stability of segmental lining in the ground

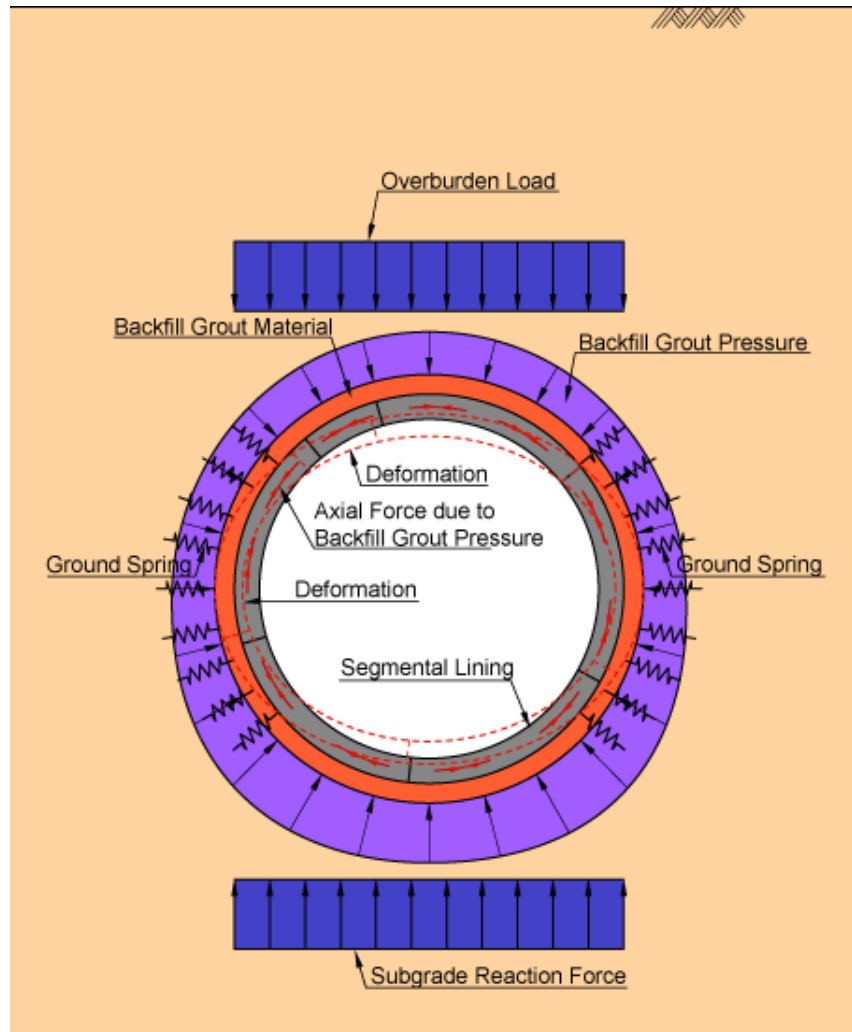

- Backfill grout injection pressure is almost uniform acted on the segmental lining when the lining to be came out from TBM tail body
- Generate axial force into the lining
- Minimize the tensile strength due to bending moment
- Backfill grout material to be hardened to transmit tunnel deformation to the ground
- Take subgrade reaction force of side ground to prevent the excessive tunnel deformation

Comparison Table for Backfill Grout Type (Part1)

Grout Type	One Component	Two Components
Material	Liquid is composed of mainly cement, flyash, sand, and bentonite. The separation of water and the aggregate (bleeding) is large.	A Liquid is composed of mainly cement and bentonite B Liquid is accelerator based on sodium silicate. The separation of water and the aggregate (bleeding) is very little.
Injection method	Grout material is pressurized with the injection pump, and injected into tail void. The material is consolidated dehydrated and filled into tail void by pressurizing of the injection pump.	A and B liquids are pressurized with the injection pumps. These two liquids are mixed and gel at the injection point in the tail void and filled into tail void by pressurizing of the injection pump.
Liquidity	Low Many injection points are required.	High The injection part is few.
Load of injection pumps	High Piston pump of a high-pressure specification is necessary.	Low
Generation of strength	Strength of material is not generated for several hours or several days.	Material gels after mixing A and B liquids. After gel, remarkable strength is not generated from ten in this material for 20 minutes. This material becomes strength of about 100kn/mm ² 1 hour later, and hardens rapidly afterwards.

Comparison Table for Backfill Grout Type (Part2)

Grout Type	One Component	Two Components
Influence with ground water	The cement milk is diluted and flowed out.	Material is not diluted and not flowed out because of gel.
Transportation method	Generally Material is transported to TBM by using the agitator car in the tunnel, because of low liquidity.	This material can pumping force feed the distance of about 2km, because of good liquidity.
Adaptability to ground	<p>Method can be demonstrated the theoretical effect under the conditions that has the enough ground cover, and is the hard ground.</p> <p>However, the method can not be demonstrated theoretical effects under the condition of shallow ground cover and soft ground. Because that kind of ground is not able to take high stress and strain, very easy to deform.</p> <p>As a result, backfill grout can not fill up the tail void and support the tunnel sufficiently and cause the ground settlement and deformation of tunnel.</p>	<p>Method can be demonstrated good backfilling in various grounds. Moreover, because the material generates strength at the early stage, the ground and the tunnel can be supported sufficiently.</p> <p>Therefore, the ground settlement and deformation of tunnel are very small under the condition of shallow ground cover and soft ground.</p>
Evaluation result	Good	Better

Characteristics of two components backfill grout material

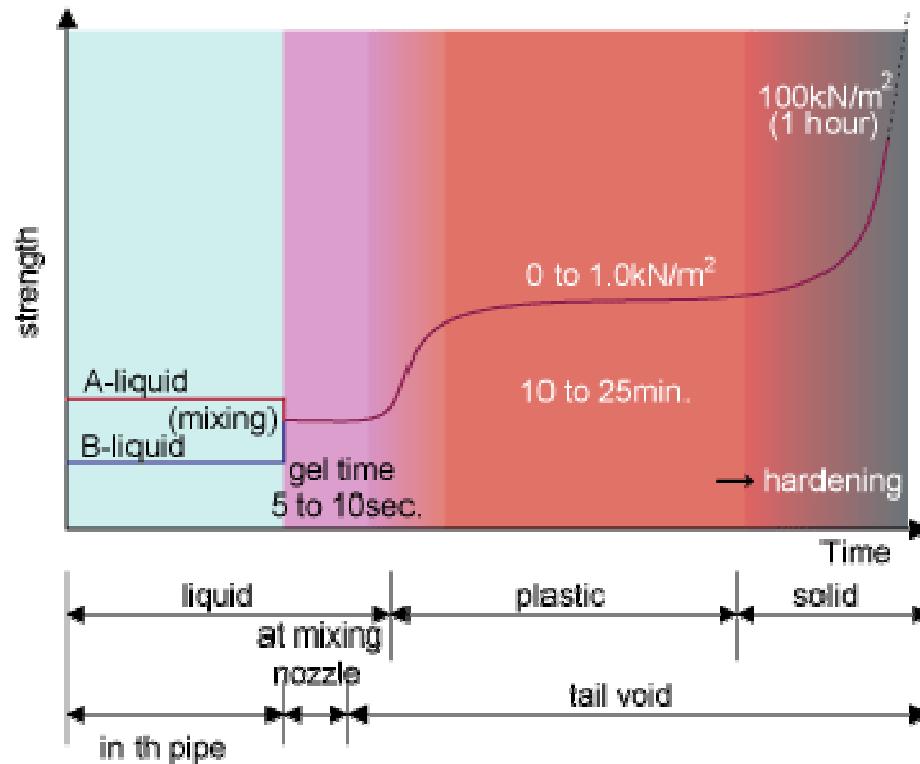

- A-liquid mainly consists of cement and bentonite
- B-liquid consists of sodium silicate
- Take 5 to 10 sec. after mixing A and B liquid, the material become to gel
- During 10 to 25 min. the material sustains plastic state
- Fluidizes easily when pressure is applied in plastic state
- Pass 30 min. the material harden quickly

Observe the distribution of segmental lining pressure

Simultaneous Backfill Grouting, Pressure Development in Construction Phase and in Long-term; written by T. Hashimoto et al : extract from the report published at ITA2004

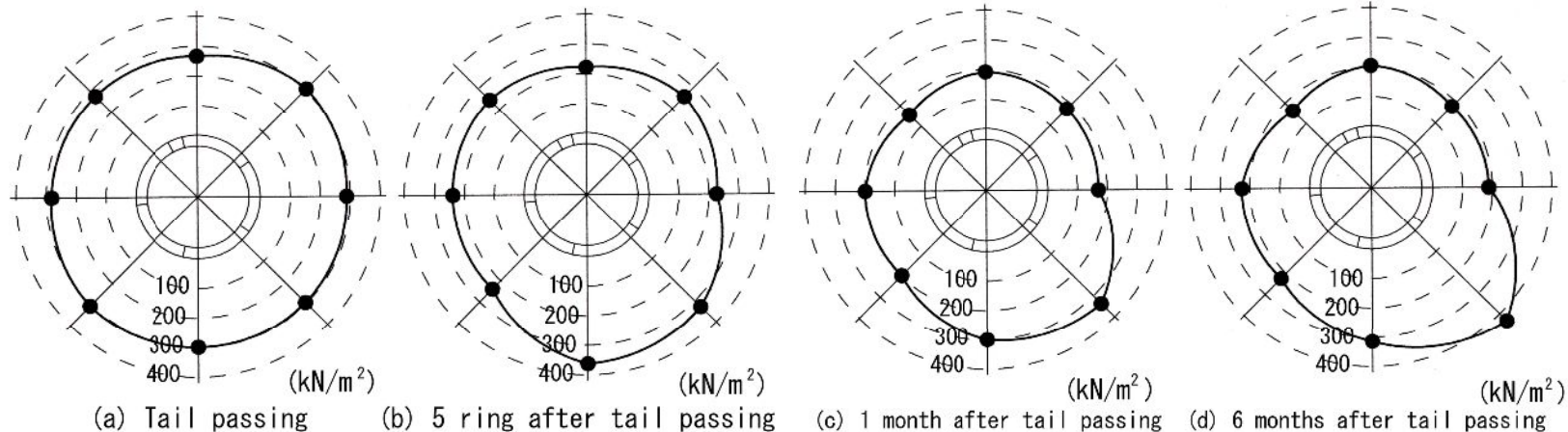

Condition of construction

- TBM O.D : 7,150mm
- overburden : 15.3m
- Soil condition : Soft Clay
- Simultaneous Backfill grouting point : 1 (top)
- Pad type pressure gauge was used to monitor the pressure acted on the lining
- At the tail passing time, almost same pressure distribution due to the injection was observed
- Passed 5 ring after, the pressure distribution was reducing
- 1 month later, the pressure distribution became ground pressure

For damage to tail brush of TBM

- Because the backfill material is low strength about one hour after mixed A and B liquids, the bond strength of the backfill grout material is smaller enough than strength of the tail brush of TBM. Therefore, the tail brush is not damaged the adhesion of backfill material.
- The risk that the two components type backfill grout material is infiltrated into the tail brush inside is lower than one component type grout. Because the two components type backfill grout material gel the infiltration is very low.
- When TBM is stopped for a long term, the bentonite solution is filled to the injection tube. At this time, the bentonite, which leak out to the ground, forms the protection cover between the tail brush and the backfill grout material. Therefore, the back-fill material does not adhere to the tail brush.

4. Outline of TAC Simultaneous Backfill Grouting Injection Pipe System

(1) Stand-by to Start the Injection

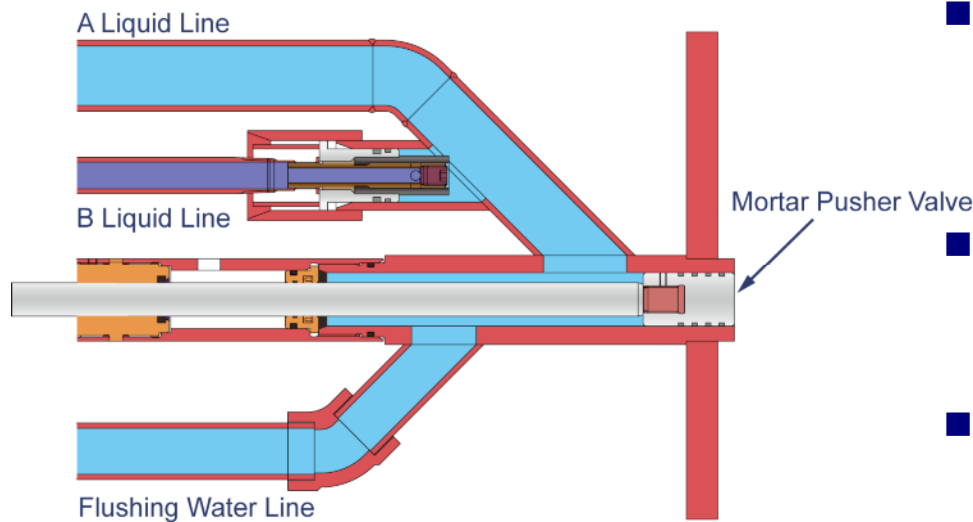

- The mortar pusher valve close the injection port at the tail end of TBM
- The injection pipe is filled with cleaning water.
- The B liquid is pressurized appropriate vale for stand-by the injection.

(2) Start A Liquid Injection

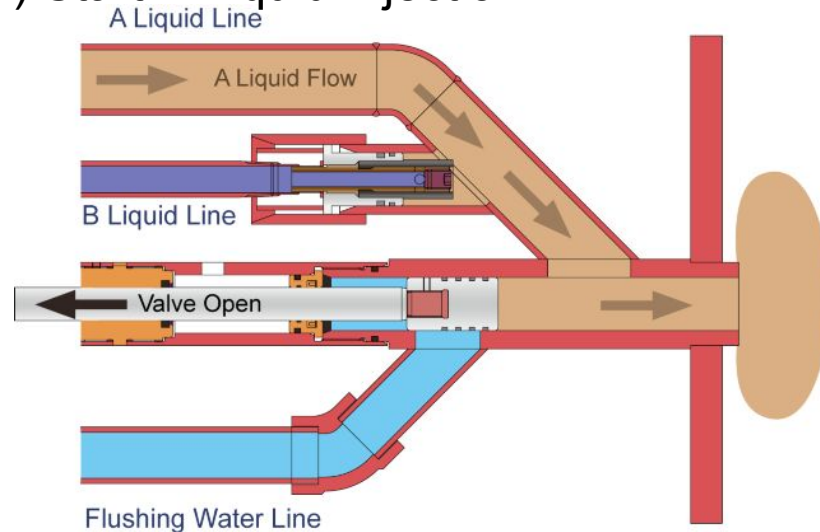

- Pull the pusher valve to open the injection port.
- The injection of A liquid begins when TBM proceeds by 20 to 30mm, and the advancing speed is steady.

(3) Start B Liquid Injection and Mix Two Liquids

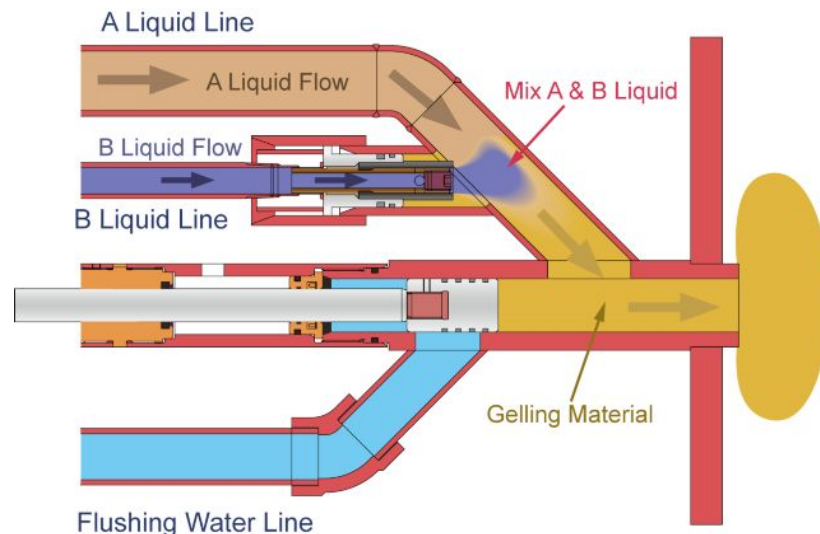

- Start the B liquid injection
- Mix A and B liquids in the injection pipe, and make homogeneous gelling material.
- Simultaneously inject the material with TBM advance.

(3) Stop the Injection and cleaning the pipe

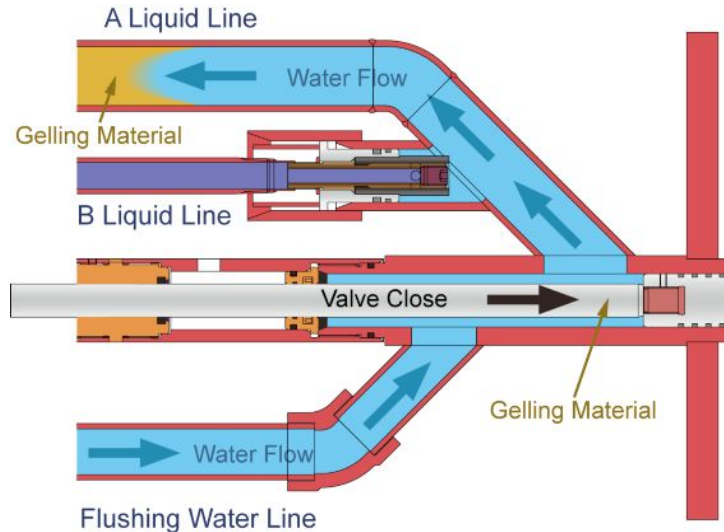

- Push out the gelling material inside the pipe to the injection port by pusher valve.
- Close the injection port by the pusher valve.
- Start to flow the cleaning water for flushing out the gelling material inside the injection pipe.
- Keep the pipe clean to prevent the trouble of pipe jamming.

QuickTimeý Ç²
 êLíÉvÉçÉOÉâÉÄ
 Ç™Ç±ÇÃÉsÉNÉ`ÉÉÇ¾å©ÇÉÇžÇ½Ç...ÇÖïKóvÇ-ÇÏÄB

5. Outline of E-TAC Backfill Grouting System

Standby on Injection

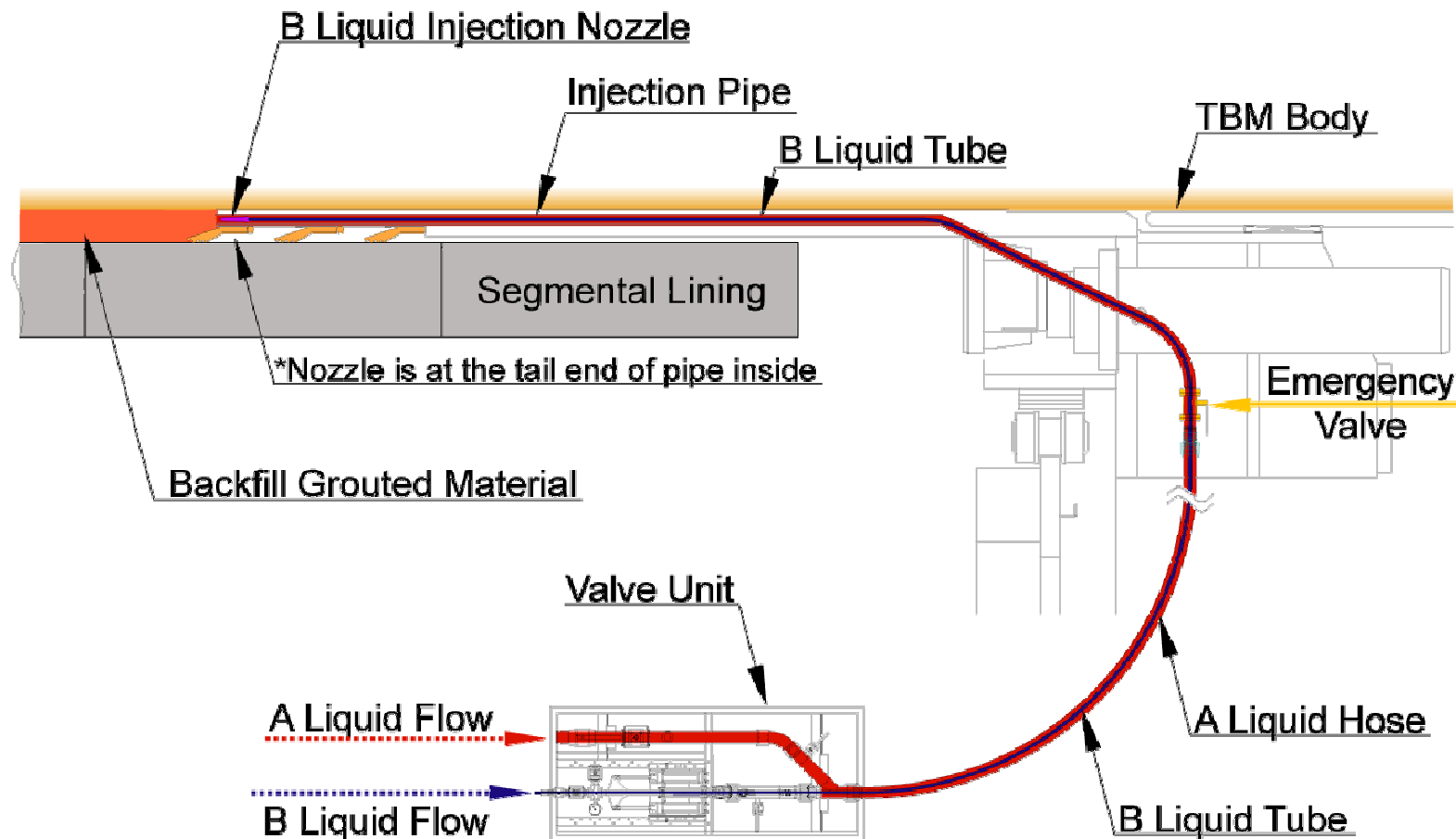

During Injection

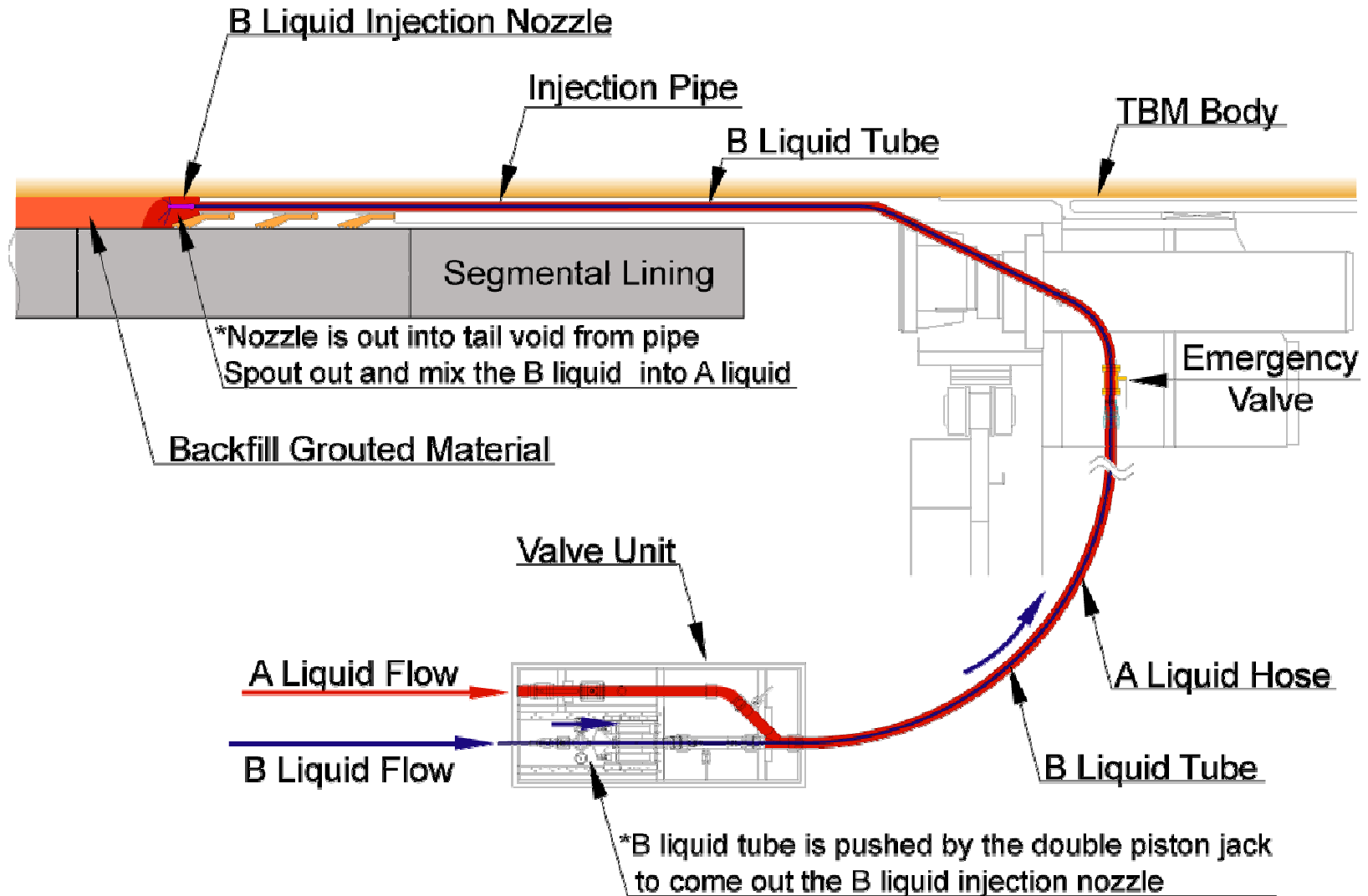

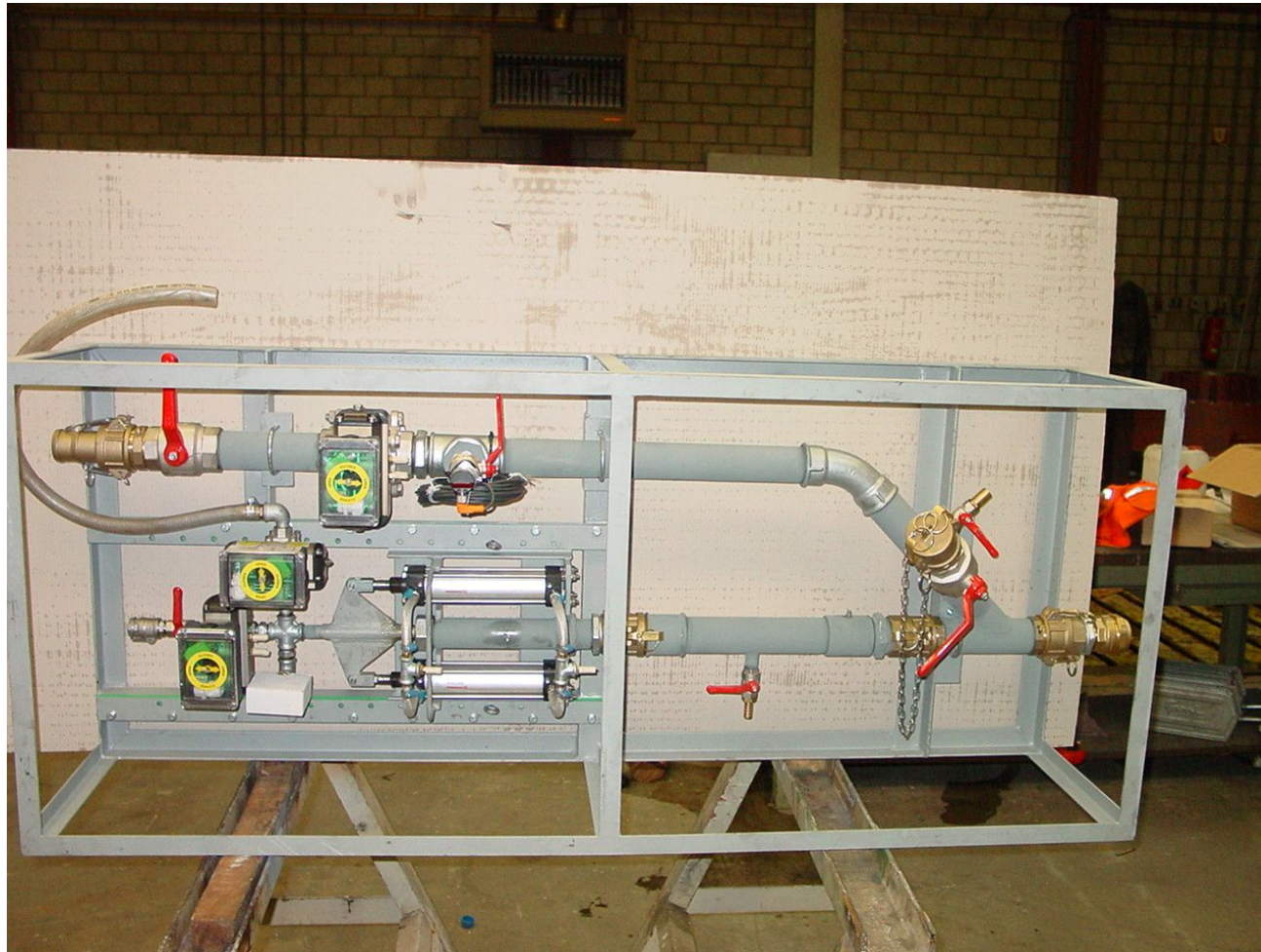

Valve unit



A liquid flow inlet and B liquid flow inlet

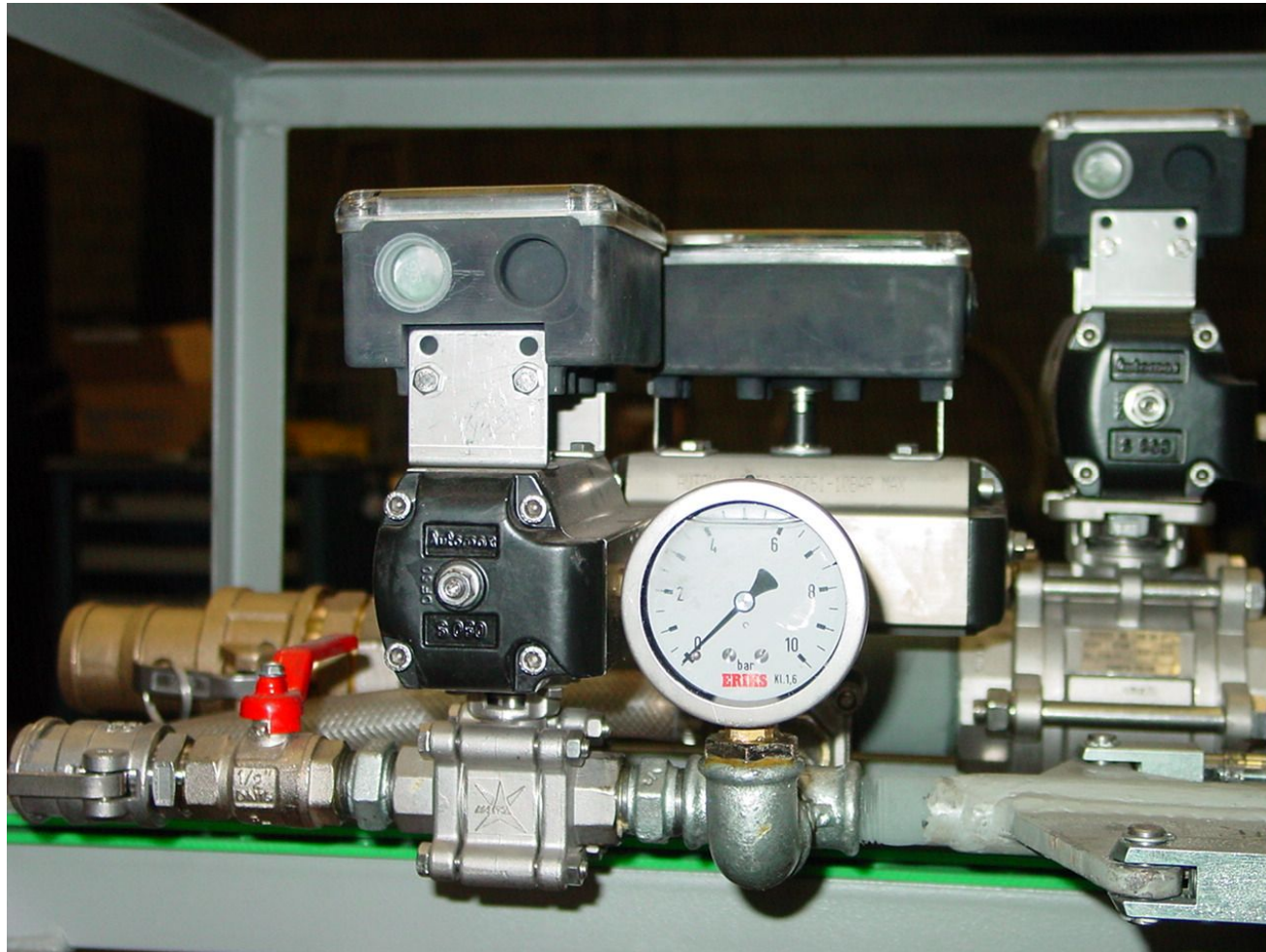
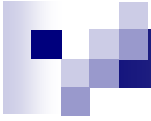

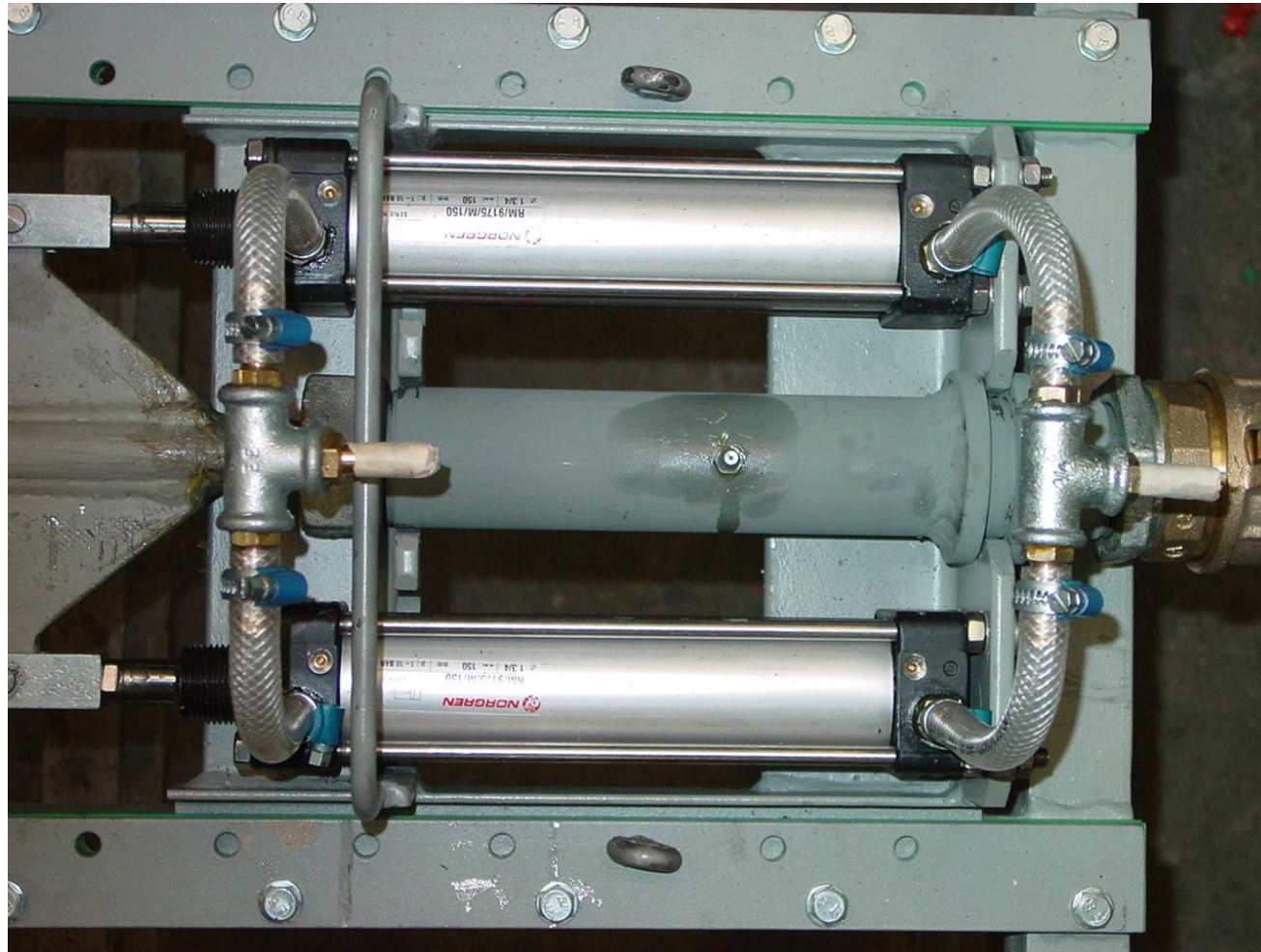

Topview of cylinders of B liquid tube

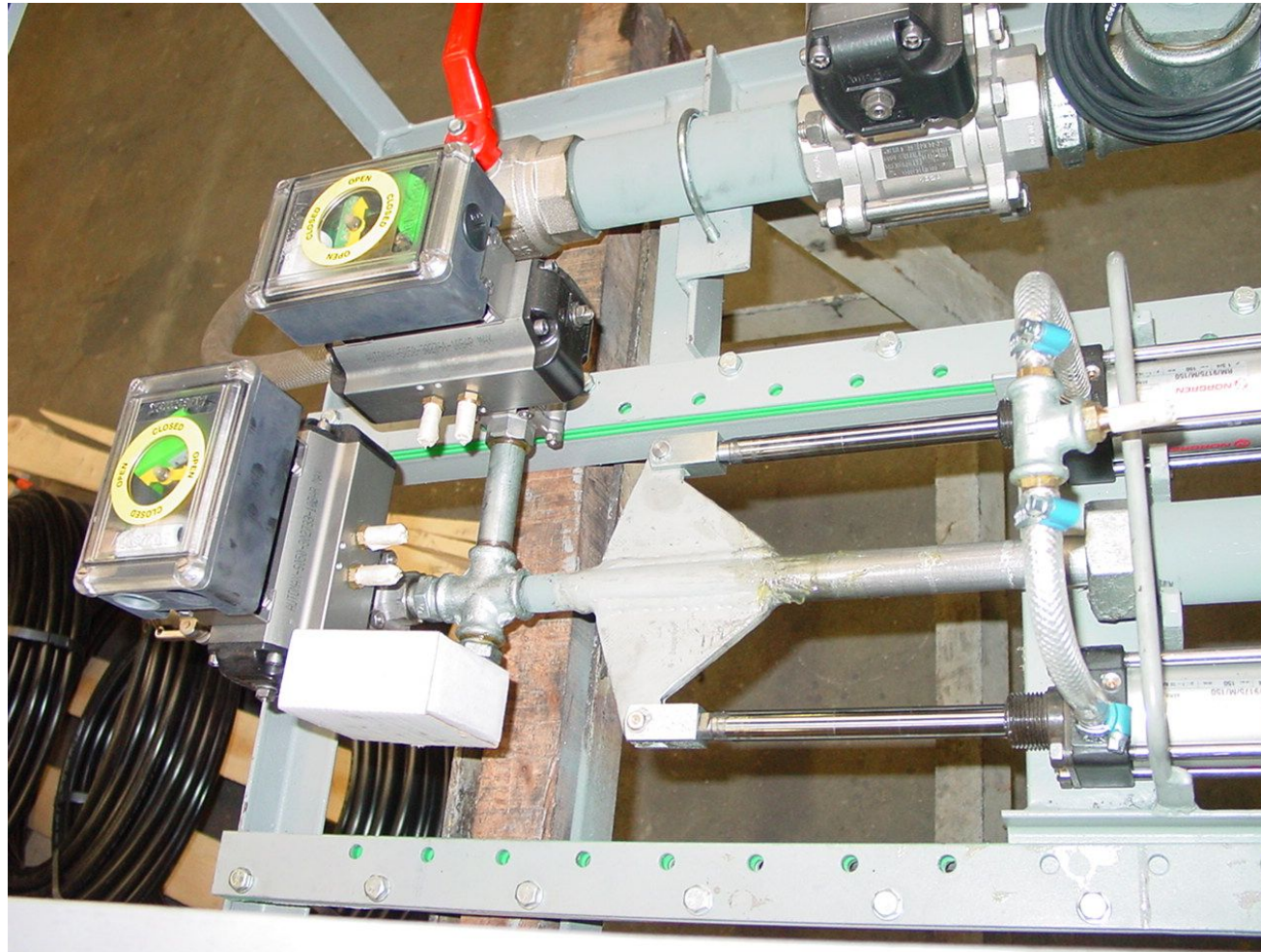

B liquid tube push & pull position

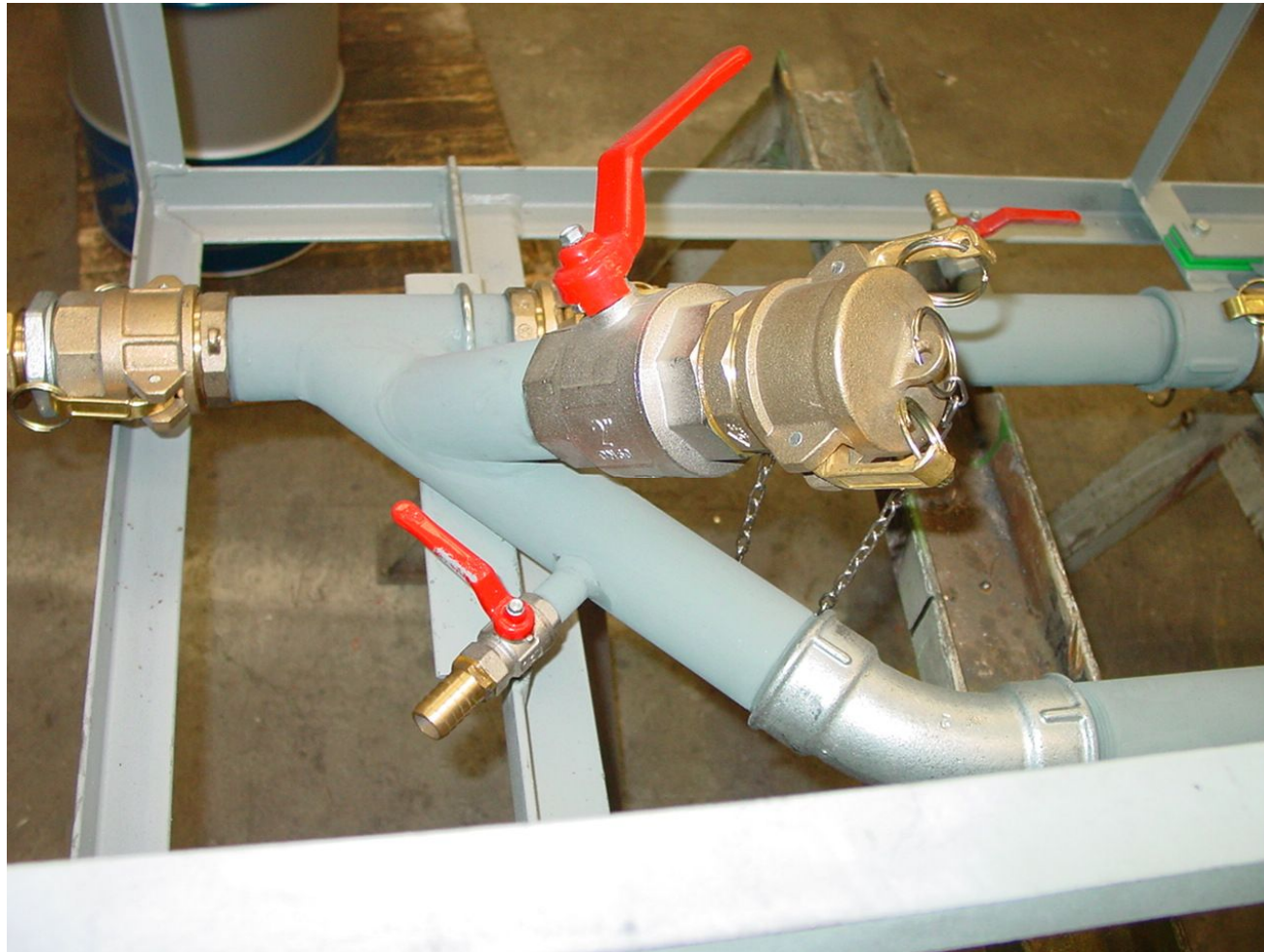

Cleaning connection (for water and bentonite)

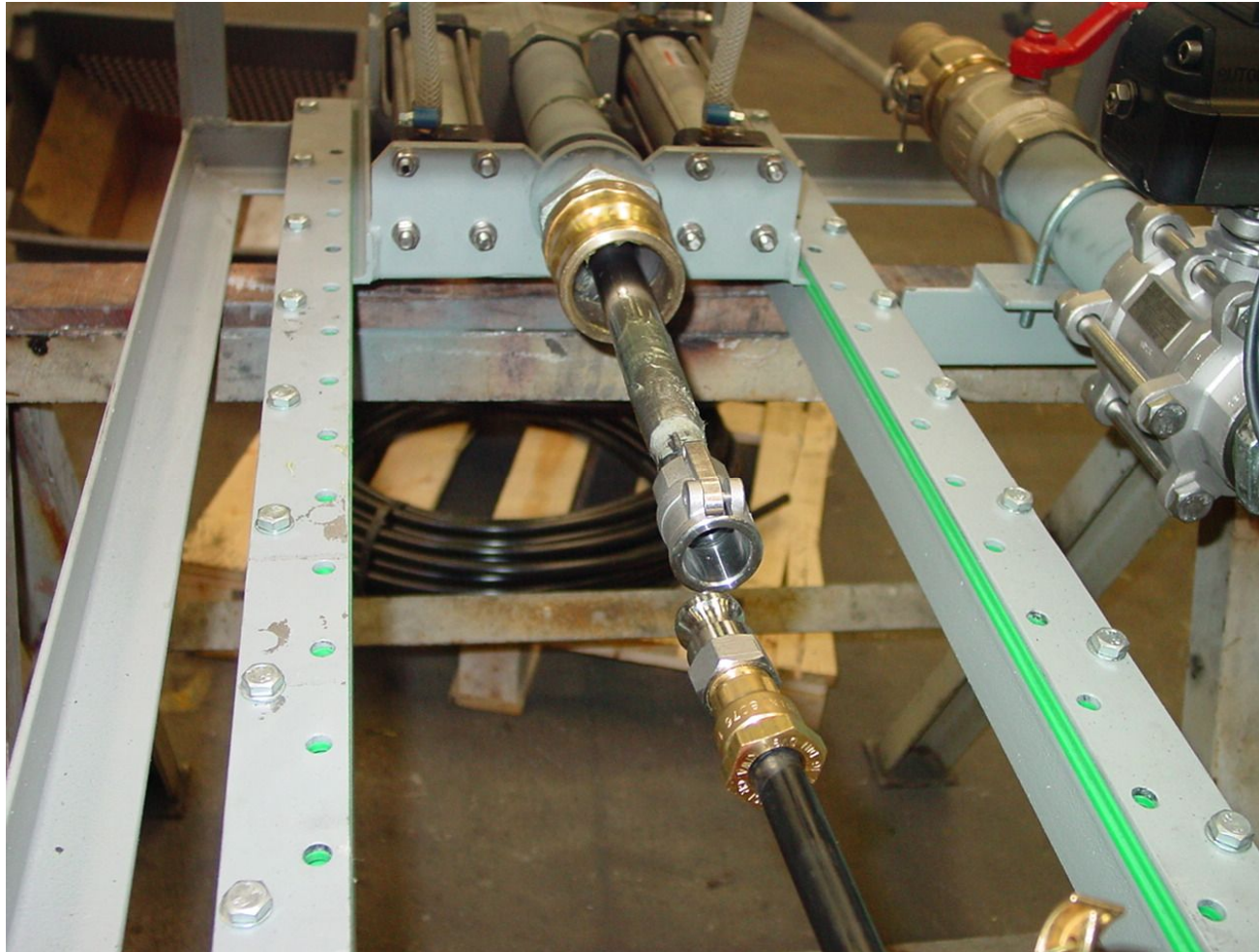

Disconnected and slid backwards



A liquid hose connection point & emergency valve



B liquid injection nozzle

6. Injection Method of E-TAC System

Injection starting procedure

1. Starting of TBM advance

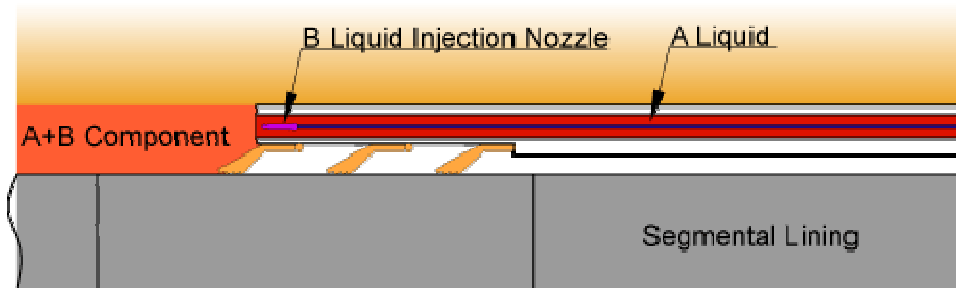

2. TBM advance 20 to 30mm

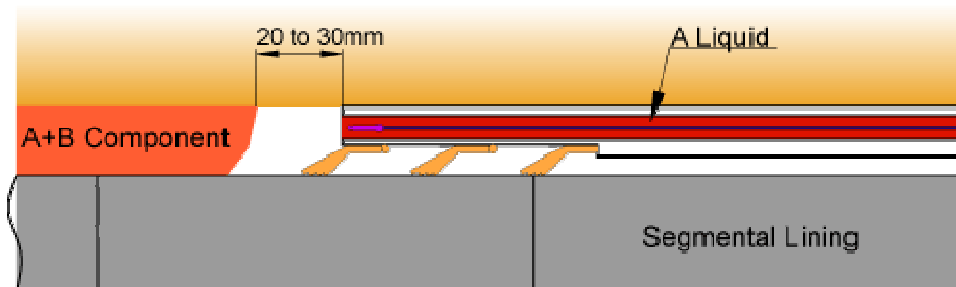

- Before TBM begins excavation, the injection pipe is filled up of A liquid
- B liquid nozzle is stored in the pipe.
- Under such a condition, TBM is advanced by 20 to 30mm.

3. A liquid flow

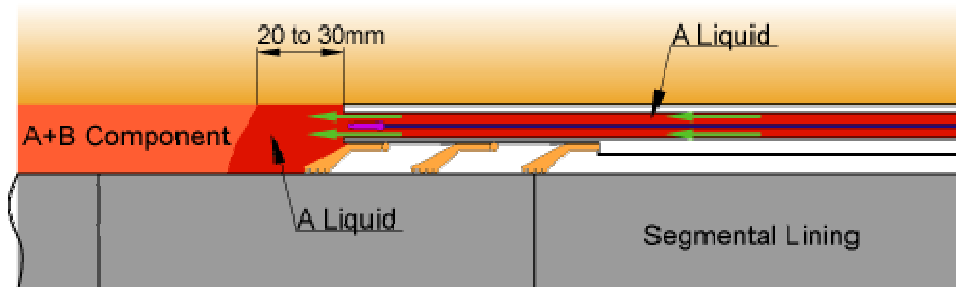

- The injection of A liquid begins when TBM proceeds by 20 to 30mm, and the advancing speed is steady.

4. Push out of B liquid nozzle and start injection

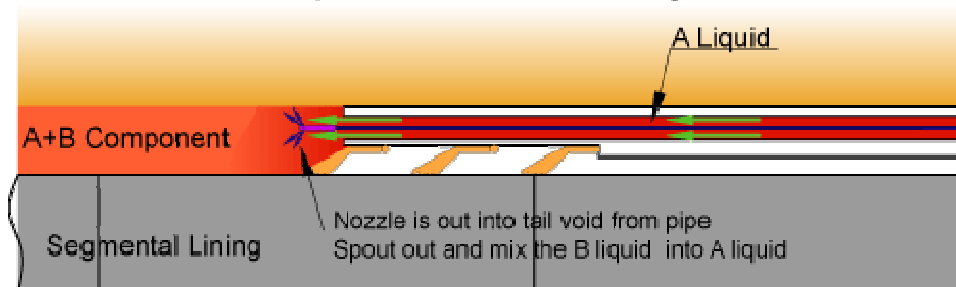

- The B liquid nozzle is pushed out to the tail void.
- Start the B liquid injection

Injection finishing procedure

1. During TBM advance

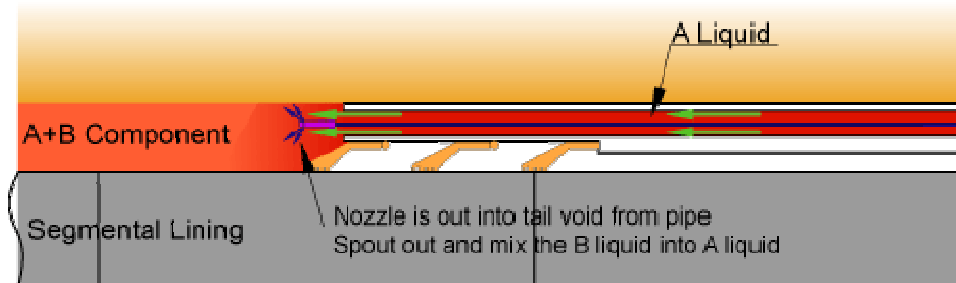

2. B liquid stopped

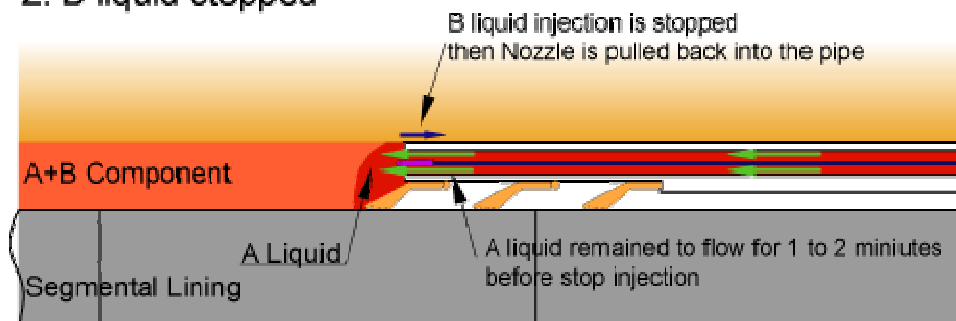

3. Stop TBM advance

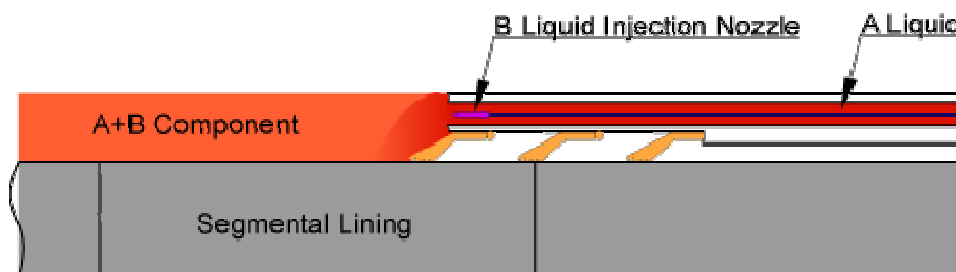

- B liquid injection is stopped 1 to 2 minutes before TBM is stopped advancing.
- The B liquid nozzle is pulled into the injection pipe.
- After TBM stops, A liquid injection is stopped.
- The decrease in the A liquid line pressure is observed while TBM is stopping.
- Pressure is maintained by an intermittent drive by starting the injection pump, when pressure decreases.

7. Maintenance for E-TAC System

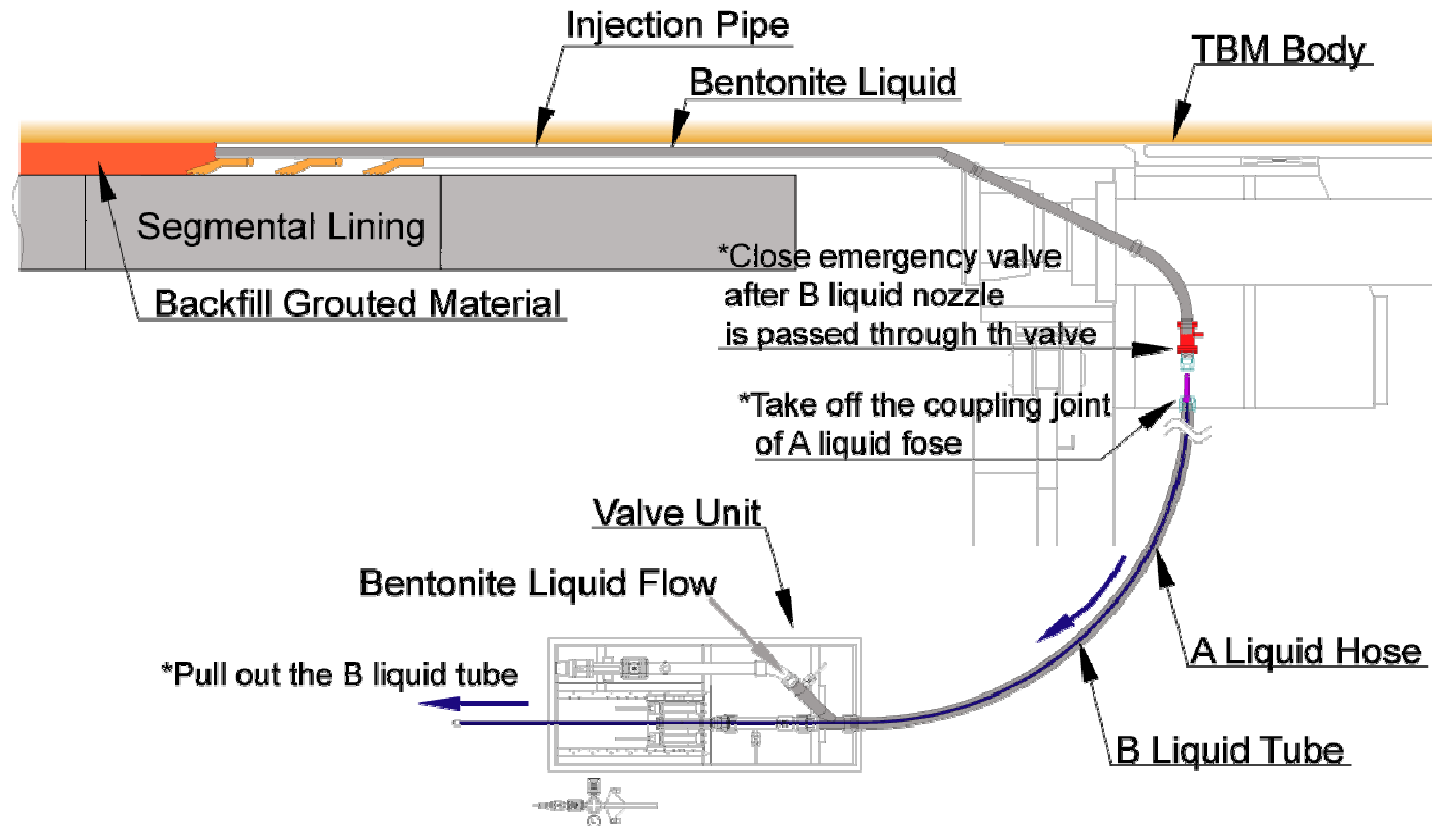

- When TBM stops to check of B liquid nozzle or TBM stops for a long term, enclose the bentonite solution into the injection pipe, pull out the B liquid hose, and close an emergency valve